



Shingled Cell



Black Backsheet  
Black Frame



Residential

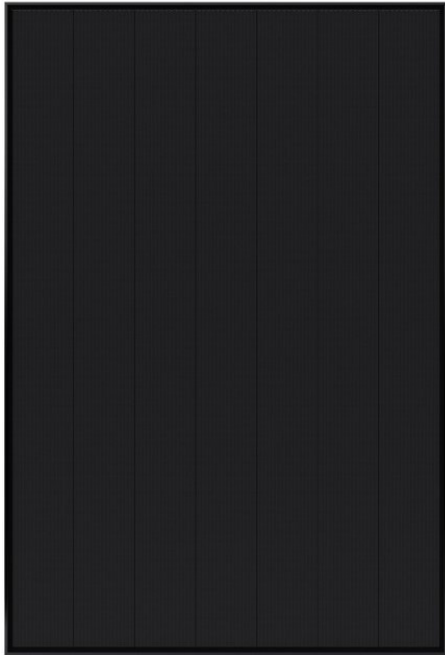

## PERFORMANCE 3 BLK

POWER RANGE: 370 - 390 W

With a sleek black design that elegantly blends into any roof, the third-generation SunPower Performance 3 panel combines enhanced warranty terms with an expanded active cell area that delivers increased power and efficiency over previous generation panels.

Backed by an industry-leading warranty and an estimated 35-year useful life,<sup>1</sup> SunPower Performance panels wrap conventional front contact cells with 35 years of materials, engineering and manufacturing expertise to mitigate the reliability challenges of Conventional Panel design.

### Engineered for Performance

- Smaller cells stay cooler when shaded, extending panel life<sup>4</sup>
- Advanced encapsulant minimizes degradation from environmental exposure
- Conductive adhesive defends against daily temperature swings
- Redundant cell connections create flexible paths for continuous electricity flow

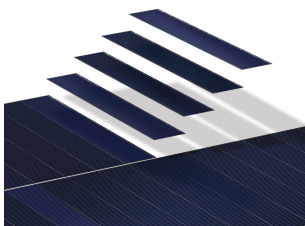

### Durability that Translates to More Energy

Engineered to stand up to environmental stresses such as shading, daily temperature swings and high humidity, the SunPower Performance 3 panel delivers up to 7% more energy in the same space over 25 years compared to Conventional mono PERC Panels.<sup>2</sup>

### A Track Record of Innovation Leadership

SunPower Performance panels represent the most deployed shingled cell panel in the industry—innovation protected by a growing portfolio of patents worldwide.<sup>3</sup>



4+ GW  
Deployed



60+  
Countries



90+  
Patents

### A Better Product. A Better Warranty.

Each SunPower Performance panel is manufactured with the confidence to deliver more energy and reliability over time—and backed for 25 years by the SunPower Complete Confidence Panel Warranty.

- Year 1 Minimum Warranted Power Output 98.0%
- Maximum Annual Degradation 0.45%
- Year 25 Minimum Warranted Power Output 87.2%

PERFORMANCE 3 BLK POWER: 370 - 390 W

Electrical Data					
Model	SPR-P3-390-BLK	SPR-P3-385-BLK	SPR-P3-380-BLK	SPR-P3-375-BLK	SPR-P3-370-BLK
Nominal Power (P <sub>nom</sub> ) <sup>5</sup>	390 W	385 W	380 W	375 W	370 W
Power Tolerance	+5/-0%	+5/-0%	+5/-0%	+5/-0%	+5/-0%
Efficiency	19.9%	19.6%	19.4%	19.1%	18.9%
Rated Voltage (V <sub>mpp</sub> )	36.7 V	36.3 V	35.9 V	35.5 V	35.1 V
Rated Current (I <sub>mpp</sub> )	10.63 A	10.61 A	10.59 A	10.57 A	10.55 A
Open-Circuit Voltage (V <sub>oc</sub> ) (+/-3%)	44.0 V	43.7 V	43.4 V	43.0 V	42.6 V
Short-Circuit Current (I <sub>sc</sub> ) (+/-3%)	11.35 A	11.31 A	11.28 A	11.26 A	11.24 A
Maximum System Voltage	1000 V IEC				
Maximum Series Fuse	18 A				
Power Temp. Coef.	-0.34% / °C				
Voltage Temp. Coef.	-0.28% / °C				
Current Temp. Coef.	0.06% / °C				

Tests And Certifications	
Standard Tests <sup>6</sup>	IEC 61215, IEC 61730
Quality Certs	ISO 9001:2008, ISO 14001:2004
EHS Compliance	OHSAS 18001:2007, Recycling Scheme
Ammonia Test	IEC 62716
Desert Test	MIL-STD-810G
Salt Spray Test	IEC 61701 (maximum severity)
PID Test	IEC 62804
Available Listings	TUV

Operating Condition And Mechanical Data	
Temperature	-40°C to +85°C
Impact Resistance	25 mm diameter hail at 23 m/s
Solar Cells	Monocrystalline PERC
Tempered Glass	High-transmission tempered anti-reflective
Junction Box	IP-67, Stäubli MC4, 3 bypass diodes
Weight	21.0 kg
Max. Load	Wind: 2400 Pa, 245 kg/m <sup>2</sup> front & back Snow: 5400 Pa, 550 kg/m <sup>2</sup> front
Frame	Class 1 black anodized

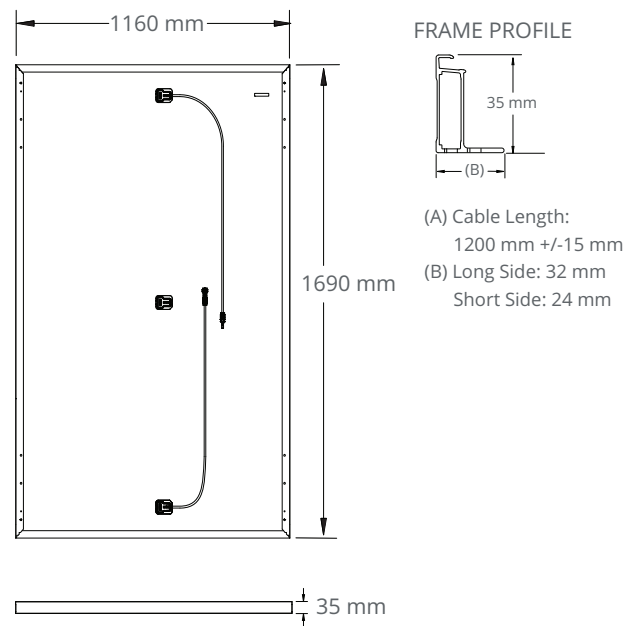

1 Performance panels expected useful life of 35 years. Source: "SunPower P-Series Technology Technical Review," Leidos Independent Engineer Report. 2016.

2 SunPower 390 W, 19.9% efficient, compared to a Conventional Panel on same-sized arrays (310 W mono PERC, 19% efficient, approx. 1.64 m<sup>2</sup>), 1% more energy per watt (based on PVSIM runs for avg EU climate), 0.1%/yr slower degradation rate (Based on Oct. 2020 review of warranties on manufacturer websites for top 20 manufacturers per IHS 2020).

3 Osborne. "SunPower supplying P-Series modules to a 125MW NextEra project." PV-Tech.org. March 2017.

4 SunPower Performance Series – Thermal Performance, Z.Campeau 2016.

5 Measured at Standard Test Conditions (STC): irradiance of 1000 W/m<sup>2</sup>, AM 1.5, and cell temperature 25° C.

6 Class C fire rating per IEC 61730.

Designed in U.S.A. by SunPower Corporation  
 Assembled in China

Specifications included in this datasheet are subject to change without notice.

© 2020 Maxeon Solar Technologies, Ltd. All Rights Reserved. View warranty, patent and trademark information at maxeon.com/legal.

Please read the safety and installation guide.

**SUNPOWER**  
 FROM MAXEON SOLAR TECHNOLOGIES